



Job Pack Price Guide

EFFECTIVE APRIL 1, 2007

Kitchen . Lavatory

Tub & Shower . Roman Tub

PRICE PFISTER

Job Pack Packaging

ON-SITE INSTALLATION MADE EASY

Price Pfister Job Packs are designed and packaged with the new work contractor's needs in mind. Our faucets are packaged in quantities suited to multiple installations on the job site.

- All major product categories are available: kitchen, lavatory, tub & shower, and roman tub.
- Our packaging is secure. It comes in a master carton with separators and unit dividers that meet the needs of you, the installer, in new work situations.
- Best of all, you get great pricing along with the superior benefits of Price Pfister ceramic disc technology.
- Price Pfister extends the Pforever Warranty® to all Job Pack products.

CERAMIC DISC VALVING

Ceramic Disc Valves last eight times longer than the industry standard. They are the ultimate in durability and reliability. Tests show that our Ceramic Disc Valves operate flawlessly for more than 4 million cycles. That is the equivalent of 80 years of normal use, or 8 times the industry standard. Ceramic is the hardest material on earth next to diamonds, withstanding even the harshest of water conditions.

Why is this so important to you? Because the biggest reason for call-backs is leaks. Our ceramic disc valving is guaranteed to be leak-free for life. Homeowners love it because the self-lubricating ceramic discs provide easier operation.

EASY ORDERING

Job Pack ordering gives you the ease and convenience for multiple installations. Job Pack products include kitchen, roman tub, lavatory, and tub & shower faucets. To order, contact your wholesale customer service representative at (800) 422-4278 or fax your order to (800) 847-4288. Job Pack product is available in case quantities only.

Some lavatory faucets require handle inserts.
 Check handle insert section.

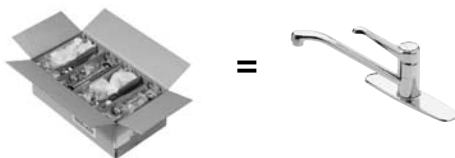

Tub & shower and roman tub faucets require at least two separate boxes to complete installations.

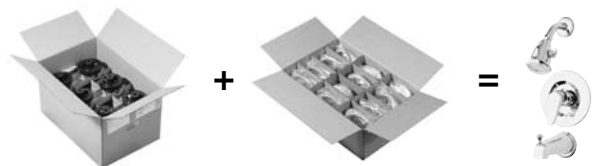

J34 - J35 Series

Single Control/Two-Handle Kitchen Faucets

The Price Pfister water saving aerator meets ANSI/ASME A112.18.1 and CSA B125 flow rate requirements of 2.2 gpm, 8.33 L/Min., Max at 60 psi.





Product	Description	Finish	Body/Complete	Catalog No.	Case Qty.	List Price
Parisa® Single Control Kitchen Faucets – Lever Handle						
Ceramic Disc Cartridge						
	3-Hole Less Spray, Less Fittings, with 16" Supply Lines	Polished Chrome	Complete	J34-1LFC	6	\$119.16
	3-Hole Less Spray, with Fittings	Polished Chrome	Complete	J34-1NCC	6	\$107.09
	3-Hole with Chrome Spray, Less Fittings with 16" Supply Lines	Polished Chrome	Complete	J34-3LFC	6	\$137.17
	3-Hole with Chrome Spray, with Fittings	Polished Chrome	Complete	J34-3NCC	6	\$125.10
	3-Hole with Stainless Steel Spray, with Fittings	Stainless Steel	Complete	J34-3NSS	6	\$184.53
	4-Hole with Chrome Spray, Less Fittings with 16" Supply Lines	Polished Chrome	Complete	J34-4LFC	6	\$139.58
	4-Hole with Chrome Spray, with Fittings	Polished Chrome	Complete	J34-4NCC	6	\$127.52
	4-Hole with Stainless Steel Spray, with Fittings	Stainless Steel	Complete	J34-4NSS	6	\$186.94
Two-Handle Kitchen Faucets – Core Handles						
Washer less Hydroseal Valves						
	3-Hole Less Spray, Metal Verve® Handles, Flo-Down® Aerator	Polished Chrome	Complete	J35-221	12	\$94.82
	4-Hole with Black Spray, Metal Verve Handles Flo-Down Aerator	Polished Chrome	Complete	J35-321	12	\$118.75
	3-Hole Less Spray, Acrylic Windsor® Handles, Flo-Down Aerator	Polished Chrome	Complete	J35-228	12	\$91.82

JOB PACK

J35 - J38 Series

Two-Handle/Pull-Out Kitchen Faucets

The Price Pfister water saving aerator meets ANSI/ASME A112.18.1 and CSA B125 flow rate requirements of 2.2 gpm, 8.33 L/Min., Max at 60 psi.

Product	Description	Finish	Body/ Complete	Catalog No.	Case Qty.	List Price
Two-Handle Kitchen Faucets – Core Handles <i>Washer less Hydroseal Valves</i>						
 	3-Hole with White Spray, Paddle Handle, Chrome Body Chrome Deck Plate Included Can be mounted without deck plate for single hole mounting option	Polished Chrome	Complete	J38-6090	6	\$160.78
 	3-Hole with Chrome Spray, Lever Handle, Chrome Body Chrome Deck Plate Included Can be mounted without deck plate for single hole mounting option	Polished Chrome	Complete	J38-60CC	6	\$151.94

J42 Series

Centerset Faucets

The Price Pfister water saving aerator meets ANSI/ASME A112.18.1 and CSA B125 flow rate requirements of 2.2 gpm, 8.33 L/Min., Max at 60 psi.

Product	Description	Finish	Body/ Complete	Catalog No.	Case Qty.	List Price	
Parisa® Single Control Centerset Faucets – Lever Handle							
Ceramic Disc Valve							
	With Metal Pop-Up, 20" Flexible Supply Lines 3/8" Compression Fittings. Includes 1/2" Male Adapter	Polished Chrome	Complete	J42-AMFC	12	\$115.81	
		Chrome/Brass	Complete	J42-AMFB	12	\$185.49	
		Satin Nickel	Complete	J42-AMFK	12	\$157.16	
		With Metal Pop-Up, 16" Copper Supply Lines, Less Fittings	Polished Chrome	Complete	J42-AMCC	12	\$126.33
			Satin Nickel	Complete	J42-AMCK	12	\$157.16
		Less Pop-Up, with Cap for Pop-Up Hole 3/8" Compression Fittings. Includes 1/2" Male Adapter	Polished Chrome	Complete	J42-ANFC	12	\$124.86

J43 Series

Centerset Faucets

Price Pfister
Pf Pfresthest Ideas in Pf faucets.

The Price Pfister water saving aerator meets ANSI/ASME A112.18.1 and CSA B125 flow rate requirements of 2.2 gpm, 8.33 L/Min., Max at 60 psi.



Product	Description	Finish	Body/ Complete	Catalog No.	Case Qty.	List Price
Two-Handle Centerset Faucets – Core Handles						
<i>Washer less Hydroseal Valves</i>						
	4" Centerset Lavatory, Acrylic Windsor Handles with Metal Pop-Up Flo-Down Aerator	Polished Chrome	Complete	J43-128	12	\$95.37
	4" Centerset Lavatory, Acrylic Windsor Handles, Not Drilled, Less Pop Up Flo-Down Aerator	Polished Chrome	Complete	J43-328	12	\$68.02

888-333-8481

J48 Series

Centerset Faucets

The Price Pfister water saving aerator meets ANSI/ASME A112.18.1 and CSA B125 flow rate requirements of 2.2 gpm, 8.33 L/Min., Max at 60 psi.

Product	Description	Finish	Body/ Complete	Catalog No.	Case Qty.	List Price
Parisa® Two-Handle Centerset Faucets Ceramic Disc Valve						
	4" Centerset Lavatory Body, Less Hubs and Handles, with Metal Pop-Up	Polished Chrome	Body, Less Handles	J48-A0XC	12	\$143.45
Recommended Handles: Conical Hub						
 ♿	Metal Lever Handles	Polished Chrome	Set of Two Handles	HHS-JLBC	2	\$56.97
		Chrome/Brass	Set of Two Handles	HHS-JCMB	2	\$62.67
 ♿	White Porcelain Lever Handles	Polished Chrome	Set of Two Handles	HHS-JLPC	2	\$56.97

How to Order Your Faucet



Lavatory Body
Part No.





Trim
Part No.

Complete
Faucet

J49 Series

Two-Handle Widespread Faucets

The Price Pfister water saving aerator meets ANSI/ASME A112.18.1 and CSA B125 flow rate requirements of 2.2 gpm, 8.33 L/Min., Max at 60 psi.

Product	Description	Finish	Body/ Complete	Catalog No.	Case Qty.	List Price
Bedford® Two-Handle Widespread Faucets Ceramic Disc Valves						
	8-15" Widespread Lavatory Body Less Hubs & Handles, with Metal Pop-Up, Flo-Down® Aerator, Quick Connect Hose Assembly	Polished Chrome	Body, Less Handles	J49-00XC	6	\$188.91
Recommended Handles: Standard Hub						
	Metal Cross Handles	Polished Chrome	Set of Two Handles	HHL-TCBC	2	\$74.07
	White Porcelain Cross Handles	Polished Chrome	Set of Two Handles	HHL-TCPC	2	\$51.28
	Metal Lever Handles	Polished Chrome	Set of Two Handles	HHL-TLBC	2	\$39.88
	White Porcelain Lever Handles	Polished Chrome	Set of Two Handles	HHL-TLPC	2	\$39.88

How to Order Your Faucet

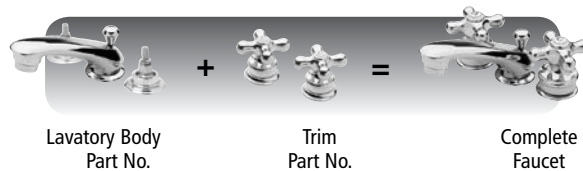

888-333-8481



J49 Series

Two-Handle Widespread Faucets

The Price Pfister water saving aerator meets ANSI/ASME A112.18.1 and CSA B125 flow rate requirements of 2.2 gpm, 8.33 L/Min., Max at 60 psi.

Product	Description	Finish	Body/ Complete	Catalog No.	Case Qty.	List Price
Parisa® Two-Handle Widespread Faucets		Ceramic Disc Valve				
	8-15" Widespread Body Less Hubs and Handles, with Metal Pop-Up, Flo-Down® Aerator, Quick Connect Hose Assembly	Polished Chrome	Body, Less Handles	J49-A0XC	6	\$217.75

Recommended Handles: Conical Hub

 ♿	Metal Lever Handles	Polished Chrome	Set of Two Handles	HHL-JLBC	2	\$56.97
		Chrome/Brass	Set of Two Handles	HHL-JCMB	2	\$62.67
 ♿	White Porcelain Lever Handles	Polished Chrome	Set of Two Handles	HHL-JLPC	2	\$56.97

How to Order Your Faucet



Lavatory Body
Part No.



Trim
Part No.

Complete
Faucet

JX8 - JX9 Series

Single Control In-Wall Valves

Price Pfister shower heads meet ANSI Standard A112.18.1: 2.5 gpm, 9.46 L/Min max flow.

Product	Description	Finish	Body/Complete	Catalog No.	Case Qty.	List Price
JX8 Single Control Ceramic Disc Pressure Balancing Valve Bodies						
	Pressure Balance Valve, Universal Fittings*, Less Stops	Unfinished	Valve	JX8-310A	12	\$69.93
	Pressure Balance Valve, Universal Fittings*, with Stops	Unfinished	Valve	JX8-340A	12	\$83.93
	Pressure Balance Valve, Female IP x Female IP, Less Stops	Unfinished	Valve	JX8-110A	12	\$69.93
	Pressure Balance Valve, Female IP x Female IP, with Stops	Unfinished	Valve	JX8-140A	12	\$83.93
	*Universal fittings (both 1/2" copper sweat and iron pipe thread)					
	OX8 Replacement Cartridge, One Piece Cartridge for Easy Retrofit or Repair	Unfinished	Part	974-042	1	\$52.56

JX8 Pressure Balance Valving. Pressure Balance valves will automatically adjust to compensate for changes in temperature due to water pressure fluctuations, such as when a toilet is flushed. When the balance between cold and hot water flowing out of the shower head changes, this valve adjusts to maintain the desired temperature at + or - 3°. It prevents scalding due to pressure fluctuations.

- Now includes ceramic disc technology
- Retrofits with previous OX8 & JX8 valves
- Withstands high-pressure start-ups
- Designed for use in recirculating systems
- Reaches 800 PSI (500 PSI pressure differential)
- Available with or without stops
- Eliminates water hammering associated with the valve

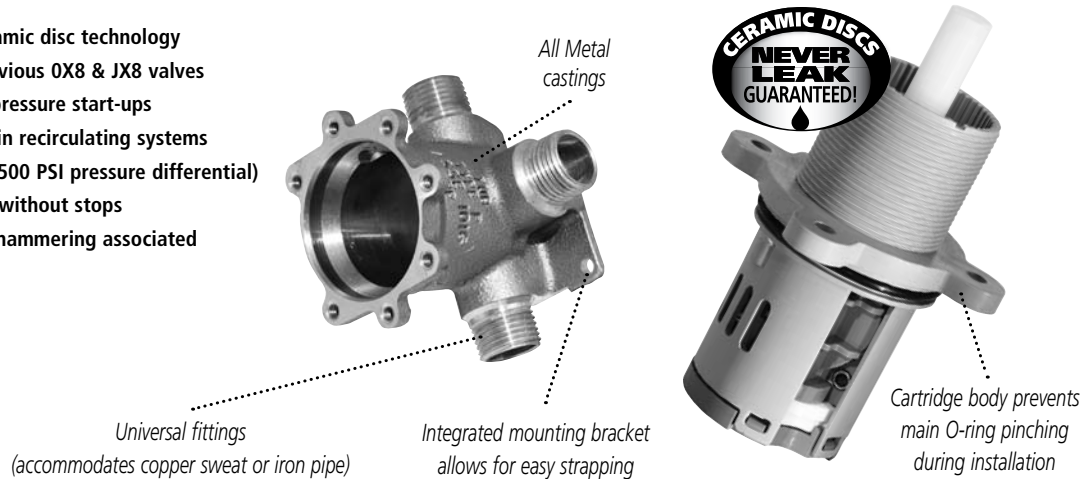







JX9 Single Control Mixing Valve Bodies

	Mixing Valve, CC x CC, Less Stops	Unfinished	Valve	JX9-010A	12	\$63.05
---	-----------------------------------	------------	-------	----------	----	---------

J89 Series

Single Control In-Wall Trim Kits









Price Pfister shower heads meet ANSI Standard A112.18.1: 2.5 gpm, 9.46 L/Min max flow.

Product	Description	Finish	Body/Complete	Catalog No.	Case Qty.	List Price
Parisa® Trim Kits – Lever Handle						
<i>Fits 0X8, JX8, 0X9 and JX9 Series Valve Bodies, Valve Not Included</i>						
	Tub & Shower, Parisa Lever Handle, Round Flange, Standard Shower Head and Tub Spout	Polished Chrome	Trim	J89-A85	12	\$64.24
	Tub & Shower, Parisa Lever Handle, Round Flange, Standard Shower Head, Quick Connect Tub Spout	Polished Chrome	Trim	J89-A85Q	12	\$58.57
	Shower Only, Parisa Lever Handle, Round Flange, Standard Shower Head	Polished Chrome	Trim	J89-A75	12	\$44.46
	Parisa Lever Handle, Round Flange	Polished Chrome	Trim	J89-A55	12	\$40.38
Trim Kits – Acrylic Handle						
<i>Fits 0X8, JX8, 0X9 and JX9 Series Valve Bodies, Valve Not Included</i>						
	Tub & Shower, Acrylic Handle, Round Flange, Standard Shower Head, Quick Connect Spout	Polished Chrome	Trim	J89-985Q	12	\$59.55
	Shower Only, Acrylic Handle, Round Flange, Standard Shower Head	Polished Chrome	Trim	J89-975	12	\$37.33
	Acrylic Handle, Round Flange	Polished Chrome	Trim	J89-955	12	\$34.19

J89 Series

Single Control In-Wall Trim Kit

Price Pfister shower heads meet ANSI Standard A112.18.1: 2.5 gpm, 9.46 L/Min max flow.

Product	Description	Finish	Body/Complete	Catalog No.	Case Qty.	List Price
Trim Kits – Round Flange						
<i>Fits 0X8, JX8, 0X9 and JX9 Series Valve Bodies, Valve Not Included</i>						
	Tub & Shower, Round Flange, Bell Shower Head & Threaded Tub Spout Less Handle	Polished Chrome	Trim	J89-80XC	12	\$98.19
		Satin Nickel	Trim	J89-8KXX	12	\$232.27
	Shower Only, Round Flange, Bell Shower Head, Less Handle	Polished Chrome	Trim	J89-70XC	12	\$68.43
		Satin Nickel	Trim	J89-7KXX	12	\$160.29
Recommended Handles: Bell Hub						
	Metal Cross Handle	Polished Chrome	One Handle	SGL-BABC	1	\$57.47
	White Porcelain Cross Handle	Polished Chrome	One Handle	SGL-BAPC	1	\$35.01
 	Metal Lever Handle	Polished Chrome	One Handle	SGL-B0BC	1	\$35.01
		Chrome/Brass	One Handle	SGL-BCMB	1	\$41.18
		Polished Brass	One Handle	SGL-BOBP	1	\$49.15
		Satin Nickel	One Handle	SGL-BKMK	1	\$50.58
 	White Porcelain Lever Handle	Polished Chrome	One Handle	SGL-B0PC	1	\$35.01



888-333-8481

JOB PACK

JT6 Series

Single Control Roman Tub

Price Pfister Roman Tub Faucets meet ANSI Standard A112.18.1.

Product	Description	Finish	Body/Complete	Catalog No.	Case Qty.	List Price
JX6 Series Single Control Rough-In						
	Single Control Rough-In Only 1/2" Sweat Inlets x 1/2" Sweat Outlets, Single Post Mount Accommodates Deck Thickness up to 2 3/4"	Unfinished	Valve Body	JX6-020R	4	\$51.98
Parisa® Collection Single Control Roman Tub Ceramic Disc Valve Included						
 	Single Control Roman Tub Must order JX6-020R Rough-In, Above	Polished Chrome	Trim	JT6-AMCC	4	\$179.15
		Chrome/Brass	Trim	JT6-AMCB	4	\$238.87
		Polished Brass	Trim	JT6-AMCP	4	\$322.47
		Satin Nickel	Trim	JT6-AMCK	4	\$358.30

Pfresh Features

- The single control Roman Tub decreases installation time by at least 50%.
- Valve and trim available separately.
- A 13 GPM flow rate at 60 psi fills tubs quickly.
- The Parisa Roman Tub completes a family of high arc single control bathroom faucets perfect for the entry level home buyer.

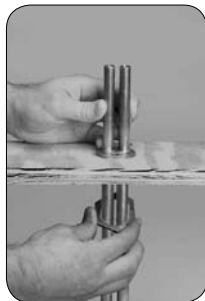

Step One: Install Rough-In to Deck

Place one-piece rough-in through single hole on deck and tighten from below.



Step Two: Secure Anchor to Rough-In

Place anchor on deck and secure with surface bolt.





Step Three: Place Faucet on Top of Anchor and Install Set Screw

Apply set screw with tool provided.

JX6 - JT6 Series

Two-Handle Roman Tub

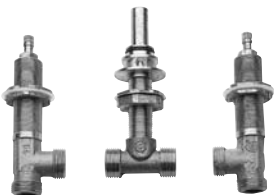
Price Pfister Roman Tub Faucets meet ANSI Standard A112.18.1.



Product	Description	Finish	Body/ Complete	Catalog No.	Case Qty.	List Price
JX6 Series Two-Handle Roman Tub Valve Bodies						
	High Flow Rough-In Only, 1/2" Sweat Inlets x 1/2" Sweat Outlets 10" Fixed Centers	Unfinished	Valve Body	JX6-040R	12	\$97.29
	High Flow Rough-In Only, 1/2" Sweat Inlets x 1/2" Sweat Outlets 1/2" Male Pipe Thread Adjustable Centers, Dual IP and Sweat, 1/2 Sweat X 1/2 Sweat or 1/2 IP X 1/2 IP	Unfinished	Valve Body	JX6-140R	12	\$86.94
JT6 Series Bedford® Spout Trim Kit – Acrylic Handles Fits JX6-040R or JX6-140R Valves						
	Bedford Collection 9" Cast Brass Spout, Acrylic Windsor Handles	Polished Chrome	Trim	JT6-238	6	\$173.94
	9" Cast Brass Spout, Deckmount includes Spout Round Acrylic Handles & Flanges	Polished Chrome	Trim	JT6-8RAC	6	\$196.90

888-333-8481

JT6 Series

Two-Handle Roman Tub





Price Pfister Roman Tub Faucets meet ANSI Standard A112.18.1.

Product	Description	Finish	Body/ Complete	Catalog No.	Case Qty.	List Price
Parisa® Trim for Roman Tub Valves <i>Fits JX6-040R or JX6-140R Valves</i>						
	Roman Tub Spout and Flanges, Less Handles	Polished Chrome	Body, Less Handles	JT6-A0XC	6	\$211.55
Recommended Handles: Standard Hub						
 ♿	Metal Lever Handles	Polished Chrome	Set of Two Handles	HHL-JLBC	2	\$56.97
		Chrome/Brass	Set of Two Handles	HHL-JCMB	2	\$62.67
 ♿	White Porcelain Lever Handles	Polished Chrome	Set of Two Handles	HHL-JLPC	2	\$56.97

JOB PACK



Handle Kits

SGL - HHS - HHL

Product	Description	Finish	Body/ Trim	SGL No.	SGL Price	HHS No.	HHS Price	HHL No.	HHL Price
Decorative Handle & Hub Trim Kits – Standard Hub Includes Handle, Hub, Button & Screw									
	Metal Cross Handle All Metal Construction	Polished Chrome	Trim	SGL-LABC	\$57.48			HHL-TCBC	\$74.07
	White Porcelain Cross Handle	Polished Chrome	Trim	SGL-LAPC	\$35.01			HHL-TCPC	\$51.28
 ♿	Metal Lever Handle All Metal Construction	Polished Chrome	Trim	SGL-80BC	\$35.01			HHL-TLBC	\$39.88
		Polished Brass	Trim	SGL-80BP	\$49.14			HHL-TLBP	\$51.28
 ♿	White Porcelain Lever Handle	Polished Chrome	Trim	SGL-80PC	\$35.01			HHL-TLPC	\$39.88

Handle Kits

SGL - HHS - HHL/J88 Series

Product	Description	Finish	Body/ Trim	SGL No.	SGL Price	HHS No.	HHS Price	HHL No.	HHL Price
Decorative Handle & Hub Trim Kits – Conical Hub									
<i>Includes Handle, Hub, Button & Screw</i>									
 	Metal Lever Handle All Metal Construction	Polished Chrome	Trim	SGL-JLBC	\$35.02	HHS-JLBC	\$56.97	HHL-JLBC	\$56.97
		Chrome/Brass	Trim	SGL-JCMB	\$41.18	HHS-JCMB	\$62.67	HHL-JCMB	\$62.67
		Polished Brass	Trim	SGL-JLBP	\$49.15			HHL-JLBP	\$68.37
 	White Porcelain Lever Handle	Polished Chrome	Trim	SGL-JLPC	\$35.02	HHS-JLPC	\$56.97	HHL-JLPC	\$56.97
Single Control In-Wall Trim Kits									
<i>Includes Handle and Two Buttons</i>									
 	Parisa® Lever Handle All Metal Construction	Polished Chrome	One Handle	SGL-AOVC	\$30.81				
		Polished Brass	One Handle	SGL-AOVP	\$43.13				
		Satin Nickel	One Handle	SGL-AOVK	\$38.02				

JOB PACK

JOB PACK INDEX

Model Number	Page No.	Case Qty.	List Price
974-042	194	1	\$52.56
HHL-JCMB	193, 199, 201	2	\$62.67
HHL-JLBC	193, 199, 201	2	\$56.97
HHL-JLPC	193, 199, 201	2	\$56.97
HHL-TCBC	192, 200	2	\$74.07
HHL-TCPC	192, 200	2	\$51.28
HHL-TLBC	192, 200	2	\$39.88
HHL-TLBP	200	2	\$51.28
HHL-TLPC	192, 200	2	\$39.88
HHS-JCMB	191, 201	2	\$62.67
HHS-JLBC	191, 201	2	\$56.97
HHS-JLPC	191, 201	2	\$56.97
J34-1LFC	187	6	\$119.16
J34-1NCC	187	6	\$107.09
J34-3LFC	187	6	\$137.17
J34-3NCC	187	6	\$125.10
J34-3NSS	187	6	\$184.53
J34-4LFC	187	6	\$139.58
J34-4NCC	187	6	\$127.52
J34-4NSS	187	6	\$186.94
J35-221	187	12	\$94.82
J35-228	187	12	\$91.82
J35-321	187	12	\$118.75
J38-6090	188	6	\$160.78
J38-60CC	188	6	\$151.94
J42-AMCC	189	12	\$126.33
J42-AMCK	189	12	\$157.16
J42-AMFB	189	12	\$185.49
J42-AMFC	189	12	\$115.81
J42-AMFK	189	12	\$157.16
J42-ANFC	189	12	\$124.86
J43-128	190	12	\$95.37
J43-328	190	12	\$68.02
J48-A0XC	191	12	\$143.45

Model Number	Page No.	Case Qty.	List Price
J49-00XC	192	6	\$188.91
J49-A0XC	193	6	\$217.75
J89-70XC	196	12	\$68.43
J89-7KXX	196	12	\$160.29
J89-80XC	196	12	\$98.19
J89-8KXX	196	12	\$232.27
J89-955	195	12	\$34.19
J89-975	195	12	\$37.33
J89-985Q	195	12	\$59.55
J89-A55	195	12	\$40.38
J89-A75	195	12	\$44.46
J89-A85	195	12	\$64.24
J89-A85Q	195	12	\$58.57
JT6-238	198	6	\$173.94
JT6-8RAC	198	6	\$196.90
JT6-A0XC	199	6	\$211.55
JT6-AMCB	197	4	\$238.87
JT6-AMCC	197	4	\$179.15
JT6-AMCK	197	4	\$358.30
JT6-AMCP	197	4	\$322.47
JX6-020R	197	4	\$51.98
JX6-040R	198	12	\$97.29
JX6-140R	198	12	\$86.94
JX8-110A	194	12	\$69.93
JX8-140A	194	12	\$83.93
JX8-310A	194	12	\$69.93
JX8-340A	194	12	\$83.93
JX9-010A	194	12	\$63.05
SGL-80BC	200	1	\$35.01
SGL-80BP	200	1	\$49.14
SGL-80PC	200	1	\$35.01
SGL-A0VC	201	1	\$30.81
SGL-A0VK	201	1	\$38.02
SGL-A0VP	201	1	\$43.13

Model Number	Page No.	Case Qty.	List Price
SGL-B0BC	196	1	\$35.01
SGL-B0BP	196	1	\$49.15
SGL-B0PC	196	1	\$35.01
SGL-BABC	196	1	\$57.47
SGL-BAPC	196	1	\$35.01
SGL-BCMB	196	1	\$41.18
SGL-BKMK	196	1	\$50.58
SGL-JCMB	201	1	\$41.18
SGL-JLBC	201	1	\$35.02
SGL-JLBP	201	1	\$49.15
SGL-JLPC	201	1	\$35.02
SGL-LABC	200	1	\$57.48
SGL-LAPC	200	1	\$35.01